

BOUNDARY GARD™ BX-80NR



Read instructions completely before beginning installation.

- Optex presents a new concept, BOUNDARY GARD™, which protects a building's exterior by detecting intruders before an entry is attempted. In addition to signaling an alarm system.
- BX-80NR is a passive infrared detector which detects the infrared heat energy that is emitted by humans and is designed with this concept.

Features

- | | |
|----------------------------------------|-----------------------------------------------------------------------------------------------------------------------------------------------------------------------------------------------------------------------------------------------|
| 1. Low current draw | : 15uA(standby) |
| 2. Battery saving circuit | : Alarm signal is generated only once with in a selected finer period, 5 or 120 seconds. |
| 3. Operates on wide range of power | : 3-9V lithium battery or alkaline battery. |
| 4. Back box for a wireless transmitter | : Back box can conceal a wireless transmitter. (Max. W40mm × H126mm × D50mm) |
| 5. High offset mounting design | : Avoid areas with unwanted objects.(80mm) |
| 6. Limited detection range function | : The detection range of the BX-80NR can be limited to avoid detecting unwanted objects. By limiting the detection range, false alarms due to unwanted movement (i.e. cars, persons or animals outside of the protected area) can be reduced. |
| 7. Size judging function | : BX-80NR is designed to discriminate between large and small objects. By utilizing this ability, false alarms due to small animals can be reduced. |
| 8. Waterproof | : IP rating IP 55 |
| 9. Double conductive shielding | : This patent listed shielding greatly reduces the risk of false alarms due to car headlights, sunlight and other ambient light sources. |

CONTENTS

- | | | |
|-------------------------------|---------------------------------|---------------------------------|
| 1. SAFETY-RELATED PRECAUTIONS | 6. WIRING | 9. WALK TEST |
| 2. DETECTION AREA | 6-1 Terminals | 10. SPECIFICATIONS & DIMENSIONS |
| 3. PARTS IDENTIFICATION | 6-2 Setting up Transmitter | 11. TROUBLE SHOOTING |
| 4. INSTALLATION HINTS | 7. AREA SETUP | |
| 5. INSTALLATION | 7-1 Area Angle Adjustment | |
| 5-1 Before the Installation | 7-2 Detection Length Adjustment | |
| 5-2 Mounting | 8. FUNCTION SETUP | |
| 5-3 Mounting on a gutter | 8-1 Sensitivity Adjustment | |
| 5-4 Wall Tamper | 8-2 DIP Switch Setup | |

1. SAFETY-RELATED PRECAUTIONS

Before installation, make sure to read this instruction manual carefully for safe and effective product operation.

	WARNING	This icon denotes a situation involving the risk of serious injury or even death, if the warning given is ignored.
	CAUTION	This icon denotes a situation involving the risk of serious injury or damage to property if the warning given is ignored.

- This icon indicates actions to be avoid. Details of the actions to be avoided are written beside or near icon. (The icon on the left indicates that the product must not be dissembled)

	Never use this product for any applications except as stated above or unexpected accidents can occur.	
	WARNING	Never attempt to connect the terminals to units which require higher power supply or current draw than its rating. It increases the risk of fire or damage to the product.
	Never attempt to disassemble or modify the product, which increases the risk of fire or damage of the product.	
	CAUTION	Avoid applying water directly from buckets, houses, or otherwise splashing water directly onto the product. It increases the risk of damaging the product.

2. DETECTION AREA

The horizontal and vertical angle of detection areas are independently adjustable on both the right and left sides of the detector. (See section 7. AREA SETUP)

IMPORTANT

This product detects temperature differences between the moving target and the background temperature of the detection area. So, if the target does not move, the detector can not detect it. Additionally, the temperature of the target may affect the detector's maximum detection range.

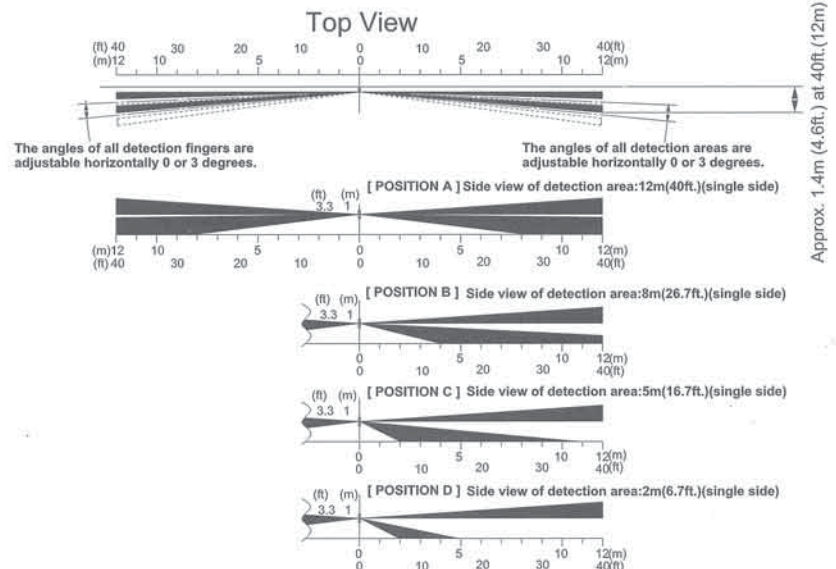

3. PARTS IDENTIFICATION

Accessories

BATTERY LEADS



006P CONNECTER CABLE



ALARM CABLE



VELCRO TAPE

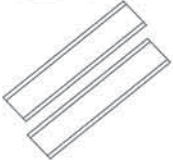

SPONGE PAD



BACK BOX

MOUNTING SCREWS(+4 × 20)

UNIT BASE

BATTERY CASE

BATTERY BASE

REFLECTOR
(Do not Touch)

BACK BOX LOCK SCREW

LENS HOLDER

LENSES

FRONT COVER

<Inside view of FRONT COVER>

FRONT COVER

COVER LOCK SCREW

LEDS

DIP SWITCH
(See section 8-2)

SENSITIVITY
SELECT SWITCH
(See section 8-1)

TAMPER

WIRING HOLE

TERMINALS
(See section 6)

<Front view of UNIT BASE>

4. INSTALLATION HINTS

Refer to the following installation hints for best product operation. If you do not follow these installation hints there is the possibility that the unit will malfunction or not operate with its best performance.

1

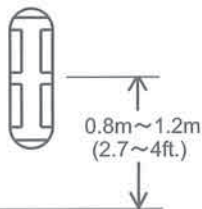

Installation height is 0.8m~1.2m.
(2.7~4ft.)

2

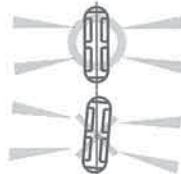

Install detector upright, with upper detection areas parallel to the ground. If detector is installed with an angle towards the ground, operational reliability of the detector may be decreased.

3

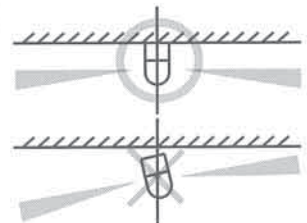

Install BX-80NR so that its detection fingers can be parallel to the wall.

4

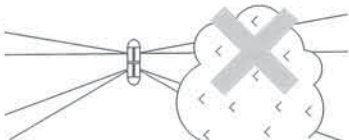

Avoid pointing detector towards moving objects (i.e. swaying tree, bushes, flag, etc.). If moving objects are unavoidable, please refer to TROUBLE SHOOTING for proper installation.

5

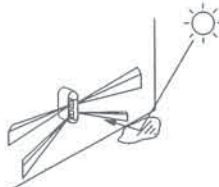

Avoid aiming the lower detection area toward the reflective objects (puddles, windows, etc.).

6

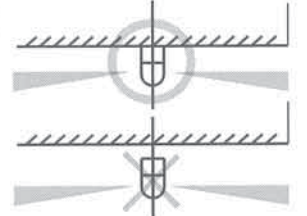

For proper activation, do not use BX-80NR away from the wall.

5. INSTALLATION

5-1. Before the installation

1

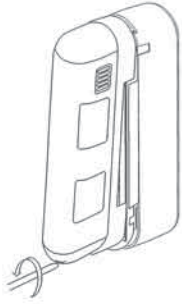

Loosen the COVER LOCK SCREW and remove the FRONT COVER. Do not touch the LENS surface.

2

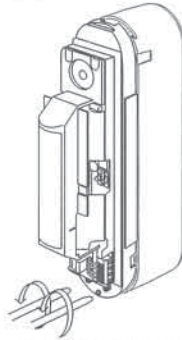

Loosen the BACK BOX LOCK SCREWS. Do not touch the REFLECTORS.

3

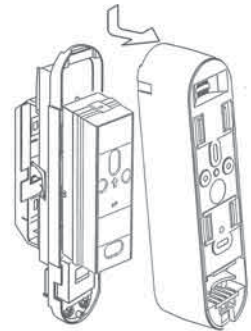

Remove the BACK BOX by sliding it down and away from the UNIT BASE.

5-2. Mounting

1

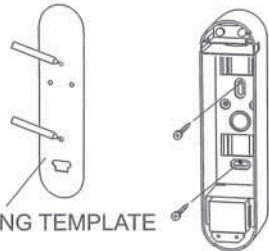

MOUNTING TEMPLATE

Use the MOUNTING TEMPLATE. Then hold the template against the mounting surface, when BX-80NR is to be mounted. Mark the position of the mounting hole then discard template. Then fasten the unit on the marked position.

2

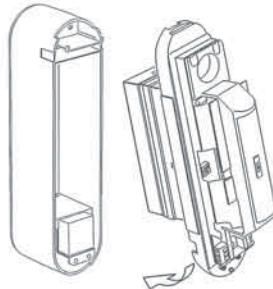

After cabling between transmitter and the unit can be fixed with 2 screws. Hook the unit onto the BACK BOX fasten turn 2 lock screws on the unit below.

3

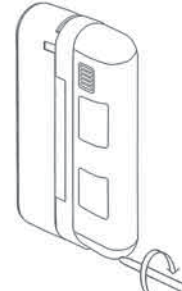

Put the cover on and conduct walk test. After completed turn the lock screw on the cover.

5-3. Mounting on a gutter

In case detection can be blocked by unwanted object it is possible to mount a gutter using Metal strap.

*Use Metal strap on the market as it is not included on this package. (Max strap size : Width 20mm / Thickness 0.5mm)

1

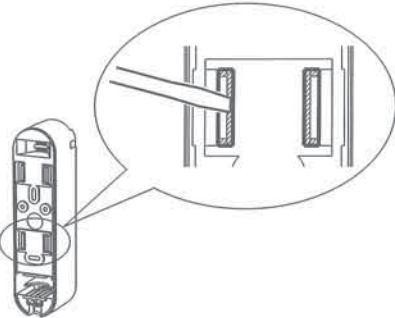

Use the knockout on the backside of the BACK BOX.

2

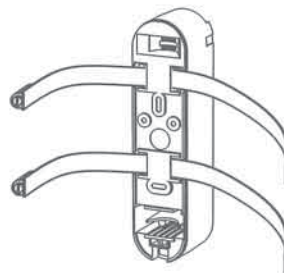

Use the metal strap to fix the unit. Tightly strap the unit on a gutter. (Max strap size : Width 20mm / Thickness 0.5mm)

3

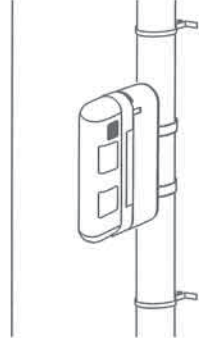

Make sure if the unit is tightly strapped.

5-4. Wall Tamper

Magnetic contact can be used as a wall tamper. *Use Magnetic contact on the market as it is not included on this package.

As for the fitting size, refer to Dimension of Magnetic contact. (See section 10.)

1

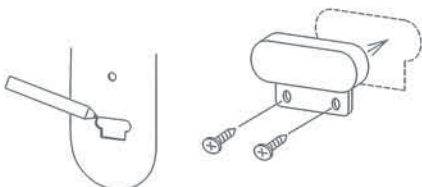

Use the enclosed MOUNTING TEMPLATE to determine where it is to be installed.

2

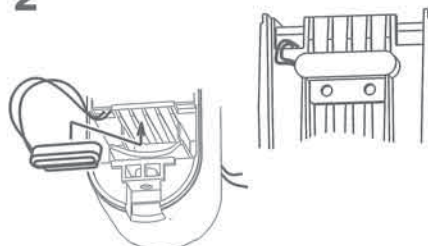

Magnetic contact with cable should be fixed on the bottom part of the BACK BOX.

3

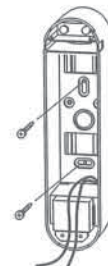

After BACK BOX is installed, magnetic contact should be connected with tamper terminal through the cable hole.

6. WIRING

6-1. Terminals

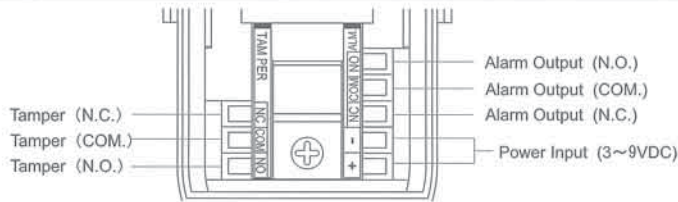

When using BX-80NR and transmitter together, the battery life will be shortened depending on the transmitter type (current draw). Only the expected battery life of BX-80NR is shown in the following chart. Battery life will change according to the temperature.

Battery Life (BX-80NR only)	Approx. 2.5 years /9V Alkaline Battery(560mAh), Interval 120sec
	Approx. 2 years /9V Alkaline Battery(560mAh), Interval 5sec
	Approx. 6 years /3V Lithium Battery(1300mAh), Interval 120sec
	Approx. 5 years /3V Lithium Battery(1300mAh), Interval 5sec

*Data shown here is when the LED is off. Battery life becomes shorter when the LED is on.

6-2. Setting up Transmitter

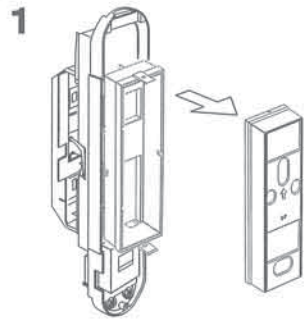

Remove the BATTERY CASE from the BATTERY BASE.

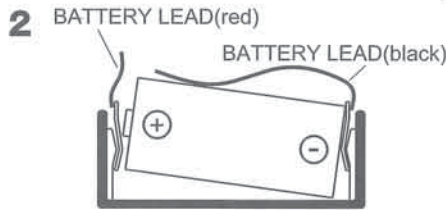

In case that BX-80NR is powered by transmitter's battery, use enclosed BATTERY LEADS. Press each lug of the lead between battery terminal and battery holder.

Note Do not strip the cable just before connecting with power terminals!! (Prevent from the short-circuit)

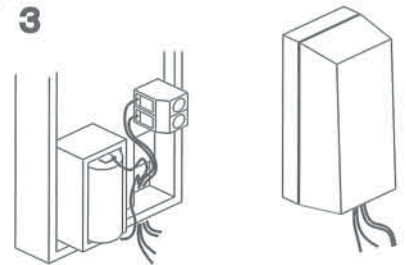

Use enclosed alarm cable to connect with alarm input terminal and draw cables out and close the cover.

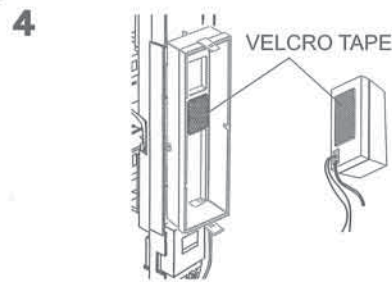

Use VELCRO TAPE to fix the transmitter in BATTERY BASE.

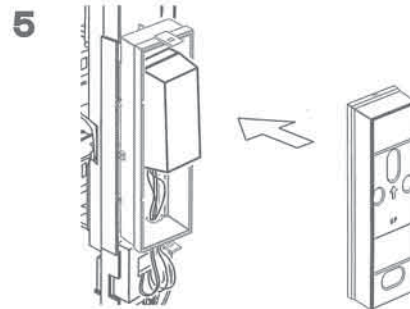

Draw cables from the bottom part of the BATTERY BASE to pass through cable hole of the unit. Close the BATTERY CASE.

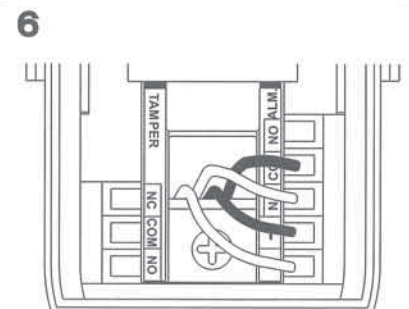

Connects cables to each terminal.

7. AREA SETUP

7-1. Area Angle Adjustment

○ If there are obstacle blocking the detection fingers, the angle of the fingers can be adjustable horizontally with the lens setting 0 or 3 degrees to keep a distance from the obstacle.
 ○ Because of the detection fingers should be set at the same angle from the wall so that they are triggered at the same time. In this case, sensitivity [H] is recommended when greater sensitivity is required around the rated area (near 12m).

IMPORTANT

• Avoid adjusting the horizontal angles of only the upper or lower detection finger separately. BX-80NR requires both upper and lower fingers to be blocked to make an alarm. So, if you adjust the horizontal angle of the detection areas, do it for both of them together. When the both angle are adjusted horizontally, sensitivity adjustment should be set to [H]. (See Section 8-1. Sensitivity Adjustment)

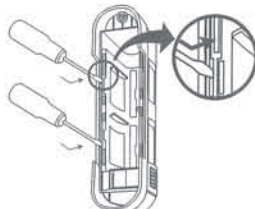

Unhook the three tabs on each side of the LENS HOLDER by inserting the blade of a screwdriver as shown above. Then, remove the LENS HOLDER from the FRONT COVER by holding the knobs on the LENS HOLDER.

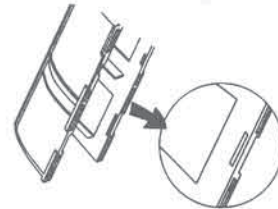

Move the LENS to select the angle (0 or 3 degree) of the detection areas as shown above and confirm that the LENS is unhooked from the groove on the LENS HOLDER.

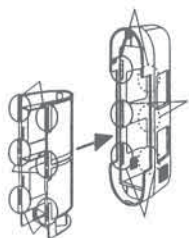

After selecting the detection area adjustment, replace the LENS HOLDER in the FRONT COVER by aligning the three tabs (A, B and C) on each side of the LENS HOLDER with the three grooves (A', B' and C') on the FRONT COVER.

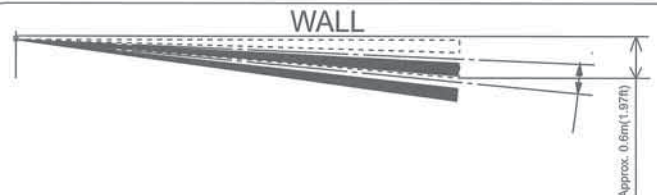

If you select the 3 degree angle, the detection area will be 0.6m(1.97ft.) away from the wall at 12m(40ft.).

7-2. Detection Length Adjustment

○The upper detection finger stays parallel to the ground at all times. The lower detection finger moves as shown in the section depending on the position. So, the length of detection is limited by the angle of lower finger, since both upper & lower fingers have to be blocked at the same time to activate detector.

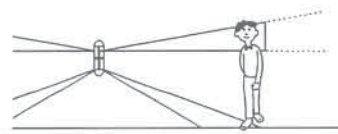

Both upper and lower finger are blocked!
Detection!

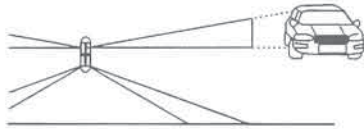

Only upper finger is blocked!
No Detection

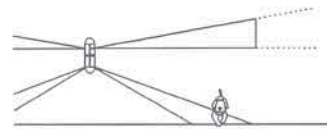

Only lower finger is blocked!
No Detection

○Adjust the detection length by sliding the lower lens as shown. (The lower areas are adjustable on right and left sides independently.) Do not press hard.



Remove the LENS HOLDER from the FRONT COVER as described in section 7-1. The lower lens slides to adjust the detection length. Select the appropriate position from the guide on the LENS HOLDER (A, B, C, or D). Make sure to conduct walk tests after changing the position. The LED light (see section 8-2) can be used to identify detection areas. If the detection areas are not appropriate, re-adjust the detection length by sliding the lens to a different position on the LENS HOLDER.

○The lower detection finger can be adjusted to control the detection length as shown below:

[Detection length setting chart]

POSITION	MAX DETECTION LENGTH m(ft)	
	Standard	*
A	12.0 (40.0)	10.0 - 15.0 (33.3 - 50.0)
	8.0 (26.7)	6.0 - 10.0 (20.0 - 33.3)
B	5.0 (16.7)	4.0 - 6.0 (13.3 - 19.8)
	2.0 (6.7)	1.5 - 3.0 (5.0 - 9.9)

Installation height=1m(3.3ft)

*The maximum detection length may vary as above due to environmental thermal conditions.

IMPORTANT

- Installation height must be between 0.8m ~ 1.2m(2.7 ~ 4ft.).
- Detection range depends on installation height.

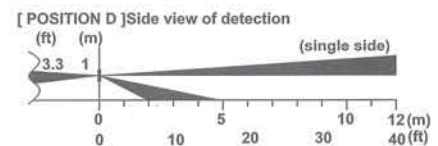
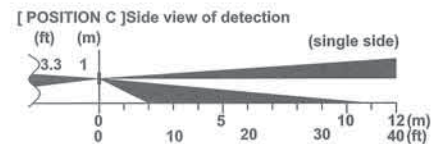
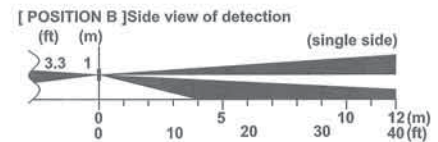
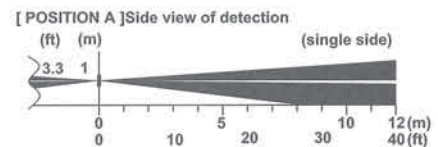

8. FUNCTION SETUP

8-1.Sensitivity Adjustment



When greater sensitivity is desired, select [H].

When the installation site is poor(bad conditions) select [L].

Sensitivity [H] is recommended when:

1. The angles of detection areas are changed in horizontal direction.
2. Greater sensitivity is required around the end of detection area(near 12m)

8-2.DIP Switch Setup



1. WALK TEST MODE

• TEST (Walk test mode)

- LED will light when detector is tripped.
- Alarm will be generated instantly on detection.

2. BATTERY SAVING TIMER

• NORM. (Normal operation : Battery saving mode)

Alarm output activations are limited by a timer selection 5 or 120 seconds. Even if there are continuous alarm events, the alarm is generated only once in the timer period which can be 5 or 120 seconds.

- 120s : The factory set timer position.
- 5s : If frequent alarm transmission is required select the "5s" option. Battery life will be shortened when using the "5s" setting.

3. LED Indicator

Select LED Indicator status : [ON] or [OFF].

9. WALK TEST

Confirm detection area referring to this section.

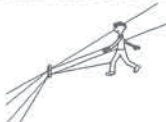

Next, make sure to switch off the WALK TEST MODE. Then, conduct walk tests near by the windows to be protected by BX-80NR and confirm if it alarms. If there is no alarm during the walk tests, the detection areas are not developed properly on horizontal direction. In this case, please see section 7 AREA SETUP and confirm if the areas are properly developed.

● Walk test should be conducted annually.

If LED are not activated when detection fingers are blocked, or LED are activated while there is nothing to detect in detection area, see section 11 TROUBLE SHOOTING.

10. SPECIFICATIONS & DIMENSIONS

MODEL	BX-80NR
Detection Method	Passive Infrared
Coverage	24m (80ft.) (12m(40ft.) on each side)
Detection Zones	4 zone (2 zone on each side)
Sensitivity	2°C at 0.6m/s (3°F at 2.0ft/s)
Detectable Speed	0.3-1.5m/s (1-5ft/s)
Power Input	3-9VDC Lithium or Alkaline Battery
Operating Voltage	2.5-10VDC
Current Draw	3mA (Walktest, LED on) 15uA (Standby)
Alarm Period	2.0±1.0 sec.
Relay Output	Form C-Solid state switch : 10VDC, 0.01A(MAX.)
Tamper Switch	Form C changes when cover removed
Walk Test Mode	ON / OFF
Warm-up Period	Approx. 2 min.
LED Indicator	Disable during normal operation
	Enable during WALK TEST or LED SW on
Operating Temperature	-20°C~+50°C(-4°F~+122°F)
Environmental Humidity	95%(MAX.)
RF Interference	No Alarm 20 V/m
Mounting	Wall (Indoor/Outdoor)
Mounting Height	0.8~1.2m (2.7~4ft.)
Weight	520g (18.4oz)
IP rating	IP55
Accessories	MOUNT SCREW (+4×20) × 2, BATTERY LEAD× 2 ALARM CABLE, 006P CONNECTER CABLE, SPONGE PAD,VELCRO TAPE× 2

※Specifications and design are subject to change without prior notice.

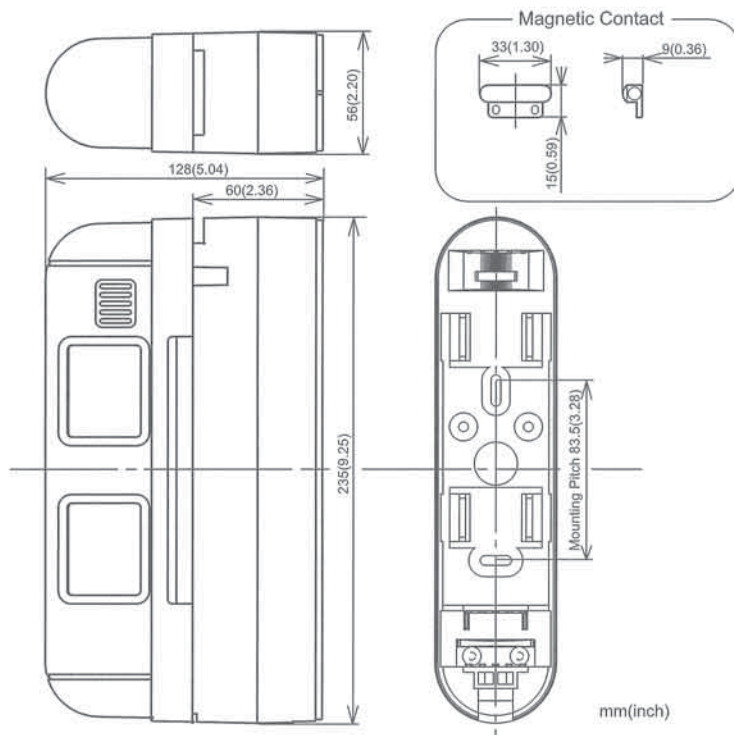

11. TROUBLE SHOOTING

PROBLEM	PROBABLE CAUSE	REMEDY
No alarm event even though someone is walking in detection area.	Incorrect power supply voltage.	Set supply voltage for a range of 3 to 9VDC battery.
	Faulty wiring to detector. Transmitter is not connected to BX-80NR	Rewire alarm correctly.
	Wireless transmission does not reach the receiver.	Check transmitter.
	Battery is dead.	Change battery.
	Battery saving timer is working.	Normal Performance. Refer to section "8-2.2. BATTERY SAVING TIMER" and "8-2.1.WALK TEST MODE".
LED blinks continuously	Incorrect power supply voltage.	Set supply voltage for a range of 3 to 9 VDC battery.
Make alarms even though no moving object is in the area	Detector is not installed perpendicular to the ground.	Reinstall the detector perpendicular to the ground.
	Lower detection area is unnecessarily long.	Confirm and reset the detection area.
	Lower detection area any object.	Remove the reflector or reset the detection area reflected light.
	Lower detection area is exposed to direct sunlight or car light.	Reset the area so it does not receive direct light.
	There is a heat source (stove or heater, etc.) in the area that may cause temperature change.	Reset the area or remove the heat source.
	There is a moving object (laundrt on clothesline, plants, etc.) in the area.	Reset the area or remove moving objects.
No detection occasionally	Detection area is not set appropriately.	Reset the area appropriately.
	Sensitivity is set for L(ow)	Reset sensitivity for M(edium) or H(igh).
No detection occasionally when conduct walk tests.	Walk test switch is OFF. (Battery saving timer is working.)	Switch ON the walk test mode. Refer to section "8-2.1.WALK TEST MODE".

This unit is designed to detect movement of an intruder and activate an alarm control panel. Being only a part of a complete system, we cannot accept responsibility for any damages or other consequences resulting from an intrusion. This product confirms to the EMC Directive 89/336 EEC.



OPTEX CO., LTD.
(JAPAN)
(ISO9001 Certified by LRQA)
(ISO14001 Certified by JET)
5-8-12 Ogoto
Otsu, Shiga 520-0101
Japan
Tel:+81-77-579-8670
Fax:+81-77-579-8190
<http://www.optex.co.jp/le>

OPTEX INCORPORATED
(USA)
13661 Benson Ave., Bldg.C.Chino,
CA 91710 U.S.A.
Tel:+1-909-993-5770
Fax:+1-909-628-5560
<http://www.optexamerica.com>

OPTEX (EUROPE) LTD.
(UK)
(ISO 9001 Certified by NQA)
Clivemont Road, Maidenhead,
Berkshire, SL6 7BU
UK
Tel:+44-1628-631000
Fax:+44-1628-636311
<http://www.optexuk.com>

OPTEX SECURITY SAS
(FRANCE)
Batiment Sis 475, Rue Piani 69480
Amberieux d'Azergues, France
Tel:+33-437-55-50-50
Fax:+33-437-55-50-59
<http://www.optex-security.com>

OPTEX KOREA CO., LTD.
(KOREA)
1001 Sambu Renaissance-Tower 456,
Kongdugck-Dong, Mapo-Gu, Seoul
Korea
Tel:+82-2-719-5971
Fax:+82-2-719-5973
<http://www.optexkorea.com>

OPTEX SECURITY SPZ O.O.
(POLAND)
ul. Bitwy Warszawskiej 1920 r. 7B, 02-366
Warszawa, Poland
Tel:+48-22-598-06-60
Fax:+48-22-598-06-61

5913802 07.07.09