

## DETECTION PATTERNS

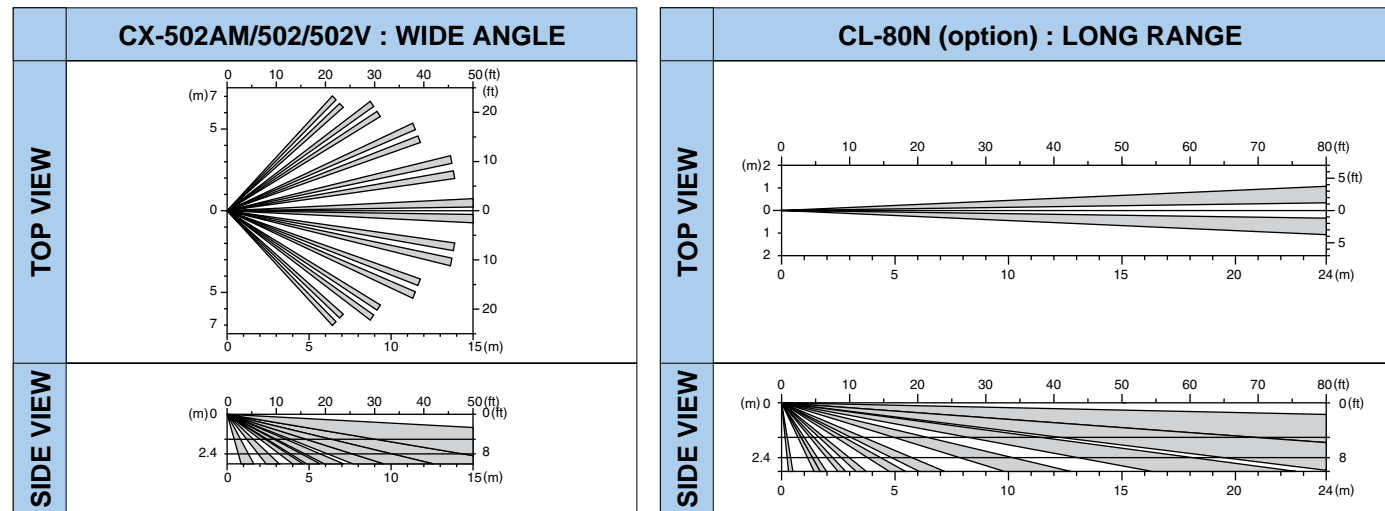

## SPECIFICATIONS

### CX-502

Detection method	Passive infrared
Coverage	Wide angle 85° wide 15m x 15m (50ft x 50ft)
Detection zones	82 zones
Mounting height	1.8 ~ 3.0m (6 ~ 10ft)
Sensitivity	1.6°C (3°F) at 0.6m/sec. (2ft/sec.)
Detectable speed	0.3 ~ 1.5m/sec. (1 ~ 5ft/sec.)
Power input	9 ~ 18VDC
Current draw	5mA (normal) / 12mA (max.)
Alarm period	2.0 ± 0.5sec.
Alarm output	N.C. 28VDC 0.2A max.
Tamper switch	N.C. Opens when cover removed
Warm-up period	Approx. 1 min. (LED blinks)
LED indicator	LED is blinking during warm-up period. Alarm condition
RF interference	No alarm 30V/m
Operating temperature	-20 ~ +50°C (-4 ~ +122°F)
Environment humidity	95% max.
Weight	120g (4.2oz)

### CX-502AM

Current draw	7mA (normal) / 19mA (max.)
Alarm memory	Selectable positive or negative control
Initial alarm memory	Selectable positive or negative control
LED indicator	Red and yellow LED is blinking during warm-up period. Red LED: Alarm, Alarm Memory and Initial Alarm Memory indicator Yellow LED: Anti-Masking and Self-Checking indicator
D.L. terminal	Selectable positive or negative control
Weight	135g (4.8oz)

### CX-502V

Current draw	5mA (normal) / 13mA (max.)
Alarm memory	Selectable positive or negative control
D.L. terminal	Selectable positive or negative control
Weight	120g (4.2oz)

UL LISTED : CX-502AM, CX-502

\*Specifications and design are subject to change without prior notice.

## OTHER CX SERIES DETECTORS

The CX series represents superior detection performance where high security is required, while eliminating false alarms, even in the most severe environments.



**CX-702**  
 21 x 21m (70 x 70ft.)  
 45 x 2.4m (150 x 8ft.)

## DIMENSIONS

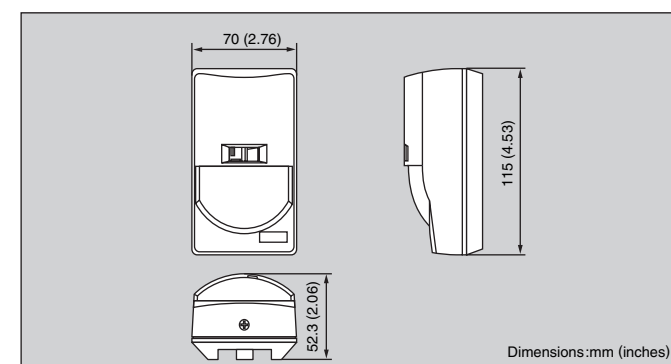

## Disturbance-Free Performance!

Optex's Multi Anti-Masking Technology prevents any detector disturbance.

- Multi Anti-Masking Technology with Highly-Sensitive Self-Checking Function
- Double Conductive Shielding of Pyroelectric Element for accurate detection
- Quad Zone Logic prevents false alarms caused from spot temperature changes
- Low Current Draw, Anti-Magnet and Silent Relays thanks to the Photo-Moss Relay



"Take Care of the Environment"  
 This catalogue uses recycled paper



OPTEX CO., LTD. (ISO 9001 Certified by LRQA)  
 4-7-5 Nishinohama Otsu, 520-0801 Japan  
 TEL (077) 524-6047 FAX (077) 522-9022  
<http://www.optex.co.jp/e/sec/index.html>

OPTEX INCORPORATED (USA)  
 OPTEX (EUROPE) LTD. (UK)  
 OPTEX SECURITY SAS (FRANCE)  
 OPTEX KOREA CO., LTD. (KOREA)

# Powerful Anti-Masking PIR Detector Eliminates False Alarms

## CX-502AM/502

Anti-Masking Model    Standard Model

### CX-502AM's IMPROVED RELIABILITY

#### Multi Anti-Masking Technology (Patent Pending)

Optex has developed the world's first Multi Anti-Masking Technology to prevent any kind of detecting disturbances by applying and developing various forms of anti-masking optical technology. Twin-Window detects with high sensitivity the variations of optical expansions and optical direction differences caused from two photoelectric detection beams. The CX-502AM, employing Multi Anti-Masking Technology developed by Optex's advanced PIR innovation, promises higher reliability performance than conventional Anti-Masking PIRs.



#### Invisible spray detection

Never worry about whether the sensor is covered with infrared beam impairing invisible sprays. The unit can also recognise black sprays.



#### Detection of pasting disturbances

The CX-502AM can recognise masking objects (e.g. invisible seals and stickers) pasted onto the PIR lens.



#### Detection of disturbances in front of the unit

The CX-502AM can also detect black paper, which tends to absorb infrared rays, when put in front of the detector from 30cm away.

#### Self-Checking

The Self-Check function is an onboard circuit which checks the operation of the detector at regular 5 hours intervals. This ensures that the unit is always working correctly.

#### Initial Alarm Memory

This function indicates by a flickering LED which detector is activated first when several detectors are connected in one alarm loop.

#### LED Remote Control Terminal (CX-502AM and CX-502V only)

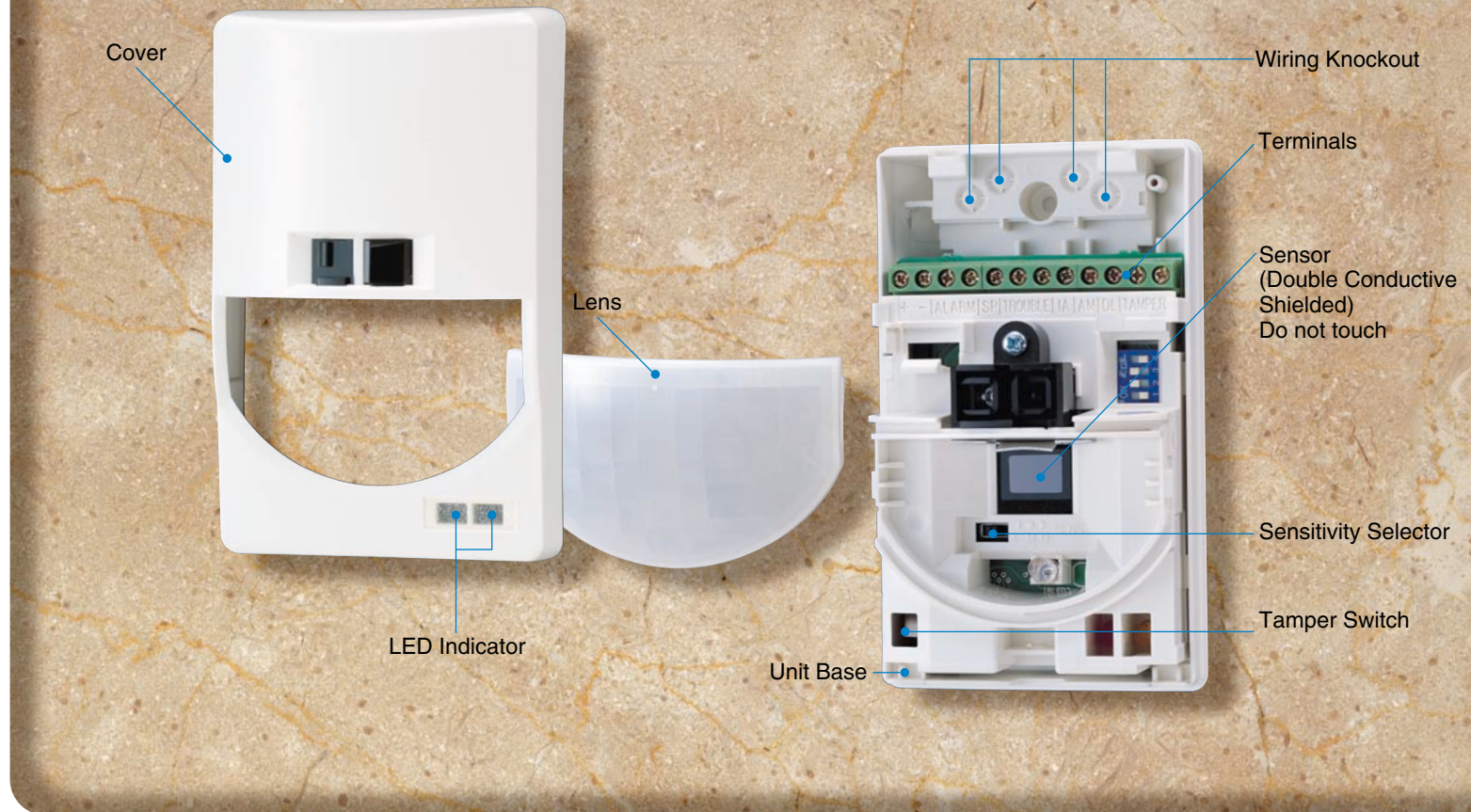

### CX-502 SERIES STABLE DETECTION PERFORMANCE

#### Quad Zone Logic (Patent Listed)

The highly accurate and reliable detection pattern will maintain its sensitivity through the entire detection area even in high temperature or low contrast environments. Quad Zone Logic creates an extremely high vertical zone density, two or three times the size of conventional PIRs. These taller zones capture the entire body mass and enable detection of even the smallest temperature contrast against the background. In addition, the vertical detection density has been improved to take into account dead zones created by furniture or partitions.

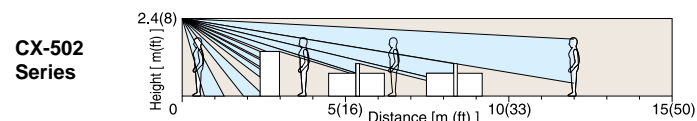
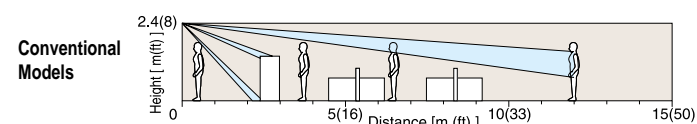
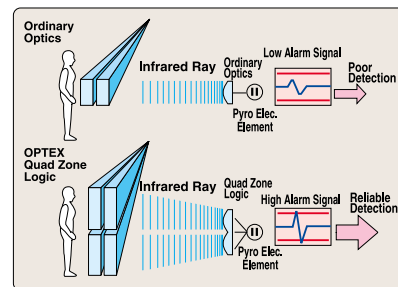

#### Temperature Compensation

Temperature Compensation will increase detection capability under high temperature conditions where the background temperature is similar to that of the human body. It maintains a high level of false alarm protection while providing accurate detection by automatically adjusting its sensitivity according to the environmental temperature.

#### Sealed Optics

Prevents drafts and small insects from getting onto the Pyroelectric Element. This practically eliminates the chance of false alarm due to these causes since the Pyro is sealed with the inside molding of the housing cover.

#### Selectable Sensitivity (High, Medium, Low)

#### Selectable Pulse Count (Standard or Special)

#### LED On/Off Switch

### FALSE ALARM PROTECTION

#### Double Conductive Shielding of the Pyroelectric Element (Patent Listed)

Double filtering and conductive metal shielding of the Pyro block out visible light and RFI, allowing only infrared energy to reach the pyroelectric elements.

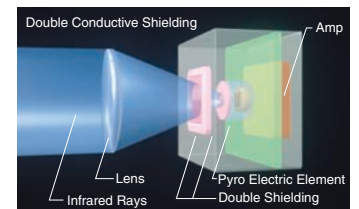

#### RFI Protection

No alarm from a field strength of 30V/m within the range of 144 to 1,200MHz.

#### Temperature Protection

No alarm in high, low and changing temperatures from -20°C to +50°C (-4°F to +122°F)

#### Visible Light Protection

### OTHER OUTSTANDING FEATURES

#### Low Current Draw

Drastic energy consumption reduction compared with conventional models.  
CX-502AM : 7mA (CX-502AMVs: 6mA)  
CX-502 and CX-502V : 5mA

#### Anti-Magnet

#### Silent-Relay

#### Easy Installation

Easy Wiring Knockout and the Easy-to-View LED help you to install the unit more simply.



#### Versions

CX-502AM-Anti-Masking  
Self-Checking  
Initial Alarm  
Memory  
CX-502 -Standard  
CX-502V -Alarm Memory

#### Options

FA-3 : Compact Wall & Ceiling  
Mount Bracket  
EA-1W : Wall Mount Bracket  
FA-1W : Multi-Angle Wall Bracket  
FA-2C : Multi-Angle Ceiling  
Bracket  
CL-80N: Long Range Lens  
24m (80ft) x 2.3m (7.7ft)